

Modulistica basi e pensili (cm)
Base and wall units size range (cm)

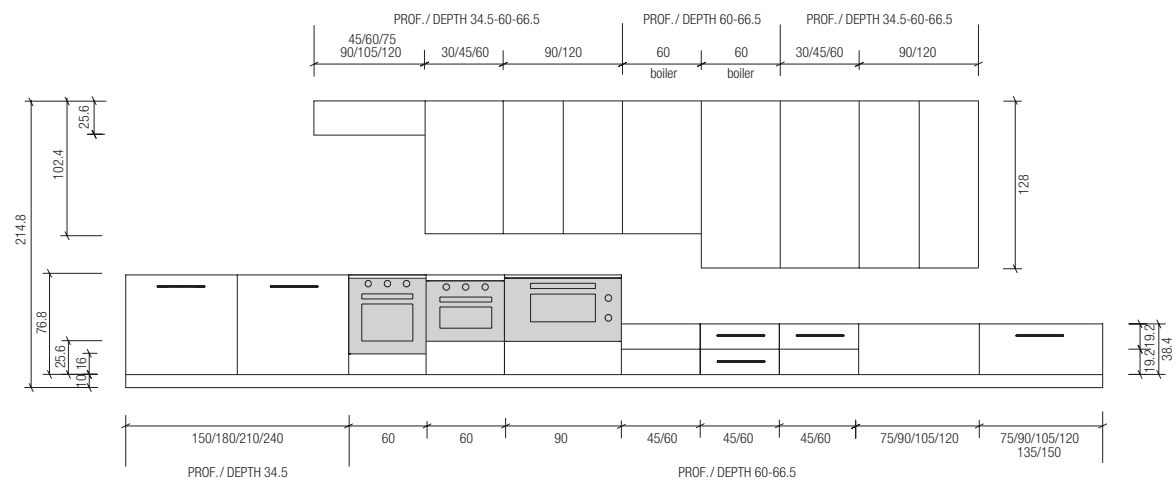

Modulistica colonne h 138 cm
Tall units 138 cm high size range

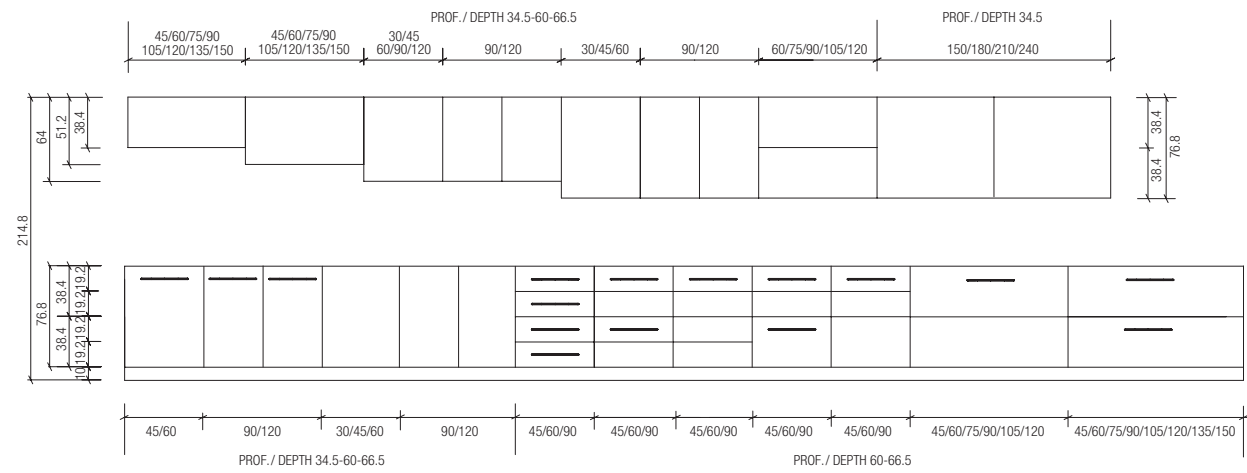
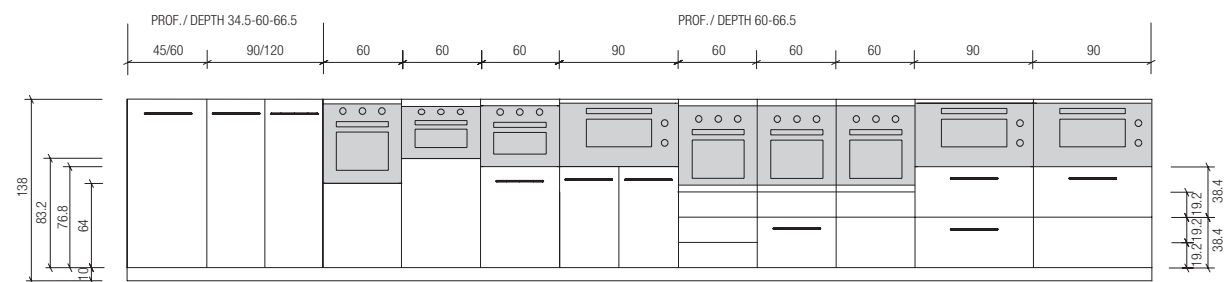

Modulistica colonne h 214.8 cm
Tall units 214.8 cm high size range

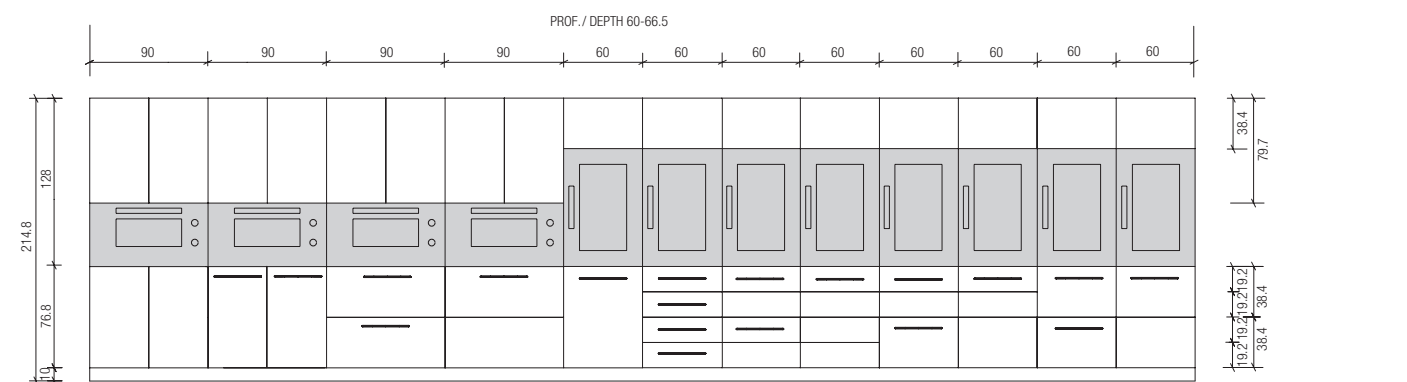
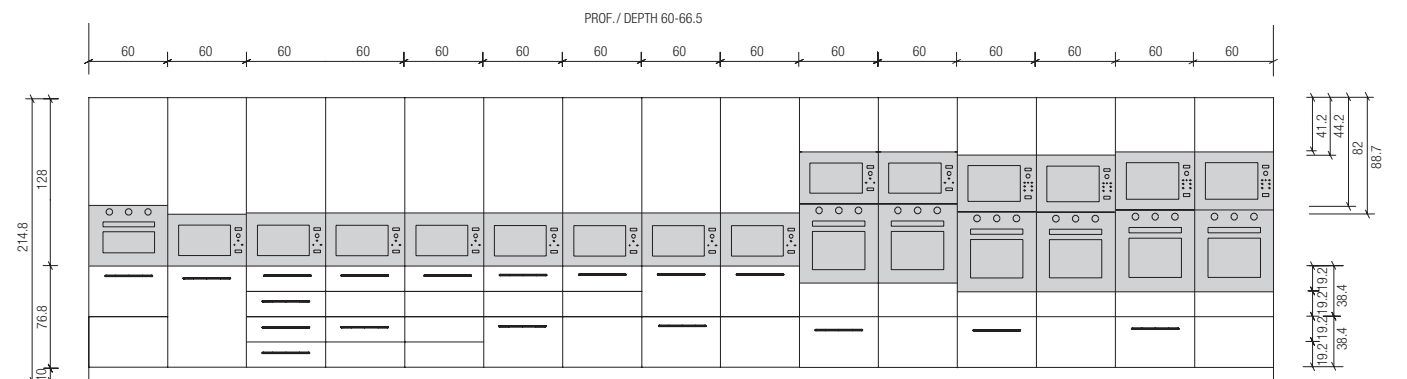
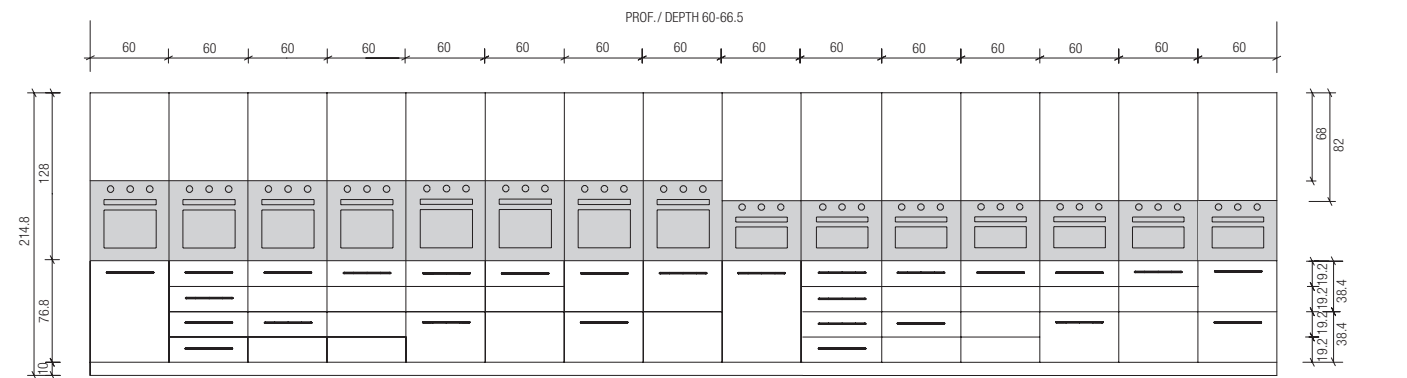
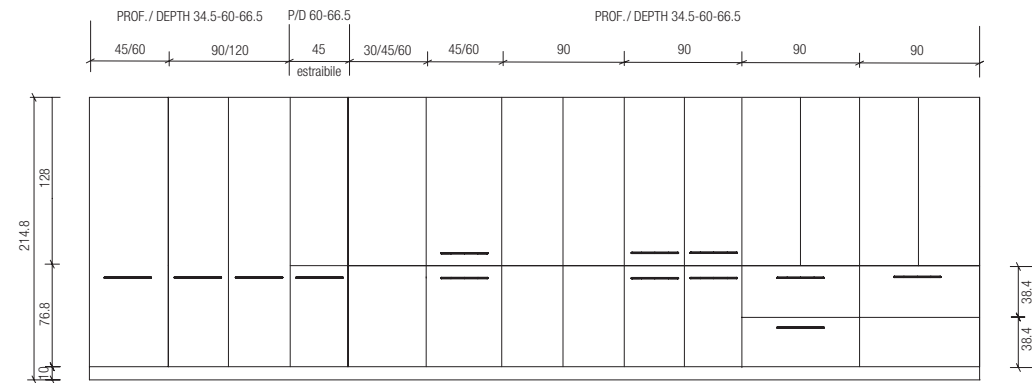

Ante, spessore 22 mm, disponibili nelle seguenti finiture:

- C** Impiallacciato rovere naturale verticale, verniciato trasparente
- D** Fenix NTM® bordato rovere naturale

Gli scaffi sono disponibili unicamente in melaminico nobilitato nero con bordo frontale in rovere naturale e tre lati in ABS nero.

Questo modello si caratterizza per vani a giorno che, nei mobili base, si completano con cassetti in massello di rovere.

Doors, 22 mm thick, available in the following finishes:

- C** Natural oak vertical veneer, varnished natural
- D** Fenix NTM® with natural oak edges

The carcasses are available only in black melamine with natural oak front edge and three sides in black ABS.

This model is characterized by open cupboards, that in the base units are completed with solid oak drawers.



Particolare maniglia / Handle detail

Tre tipologie di maniglia:

- Art. 1RV, in massello di rovere naturale;
- Art. 2GN, in metallo verniciato effetto ghisa;
- Art. 2RV, in massello di rovere naturale.

Three typologies of handle:

- Art. 1RV, in solid natural oak;
- Art. 2GN, in varnished metal cast iron effect;
- Art. 2RV, in solid natural oak.

Specificare la scelta della maniglia al momento dell'ordine.

When ordering, please specify the handle.

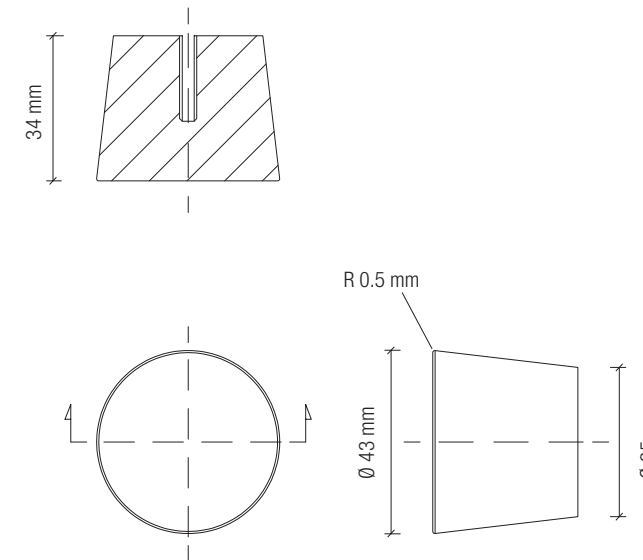

1RV - Maniglia tornita in massello di rovere naturale.
1RV - Handle turned in solid natural oak.

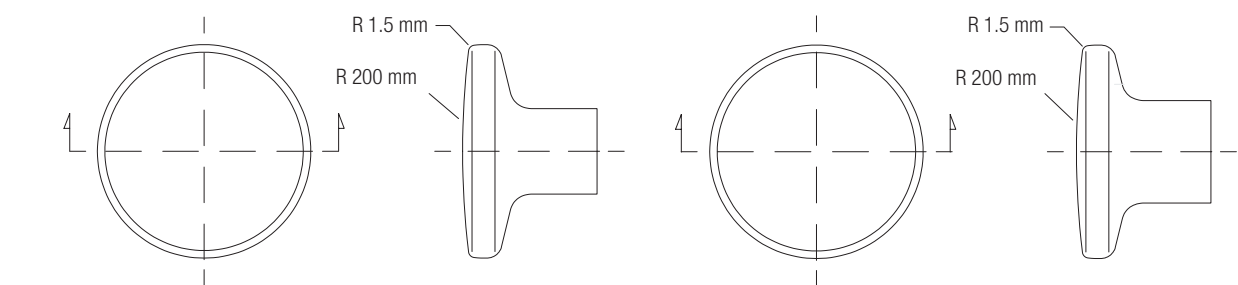
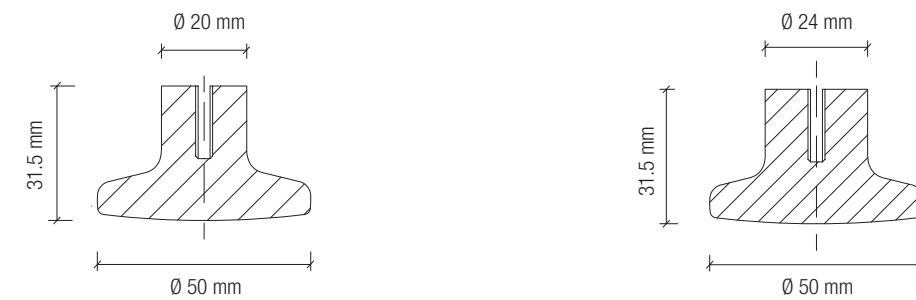

2GN - Maniglia tornita in metallo verniciato effetto ghisa.
2GN - Handle turned in varnished metal cast iron effect.

2RV - Maniglia tornita in massello di rovere naturale.
2RV - Handle turned in solid natural oak.

ante e finiture / doors and finishes

laccati opachi (C2) o lucidi (S2) / mat (C2) or shiny (S2) lacquered finishes



Bianco
White

Avorio chiaro
Light ivory

Beige chiaro
Light beige

Grigio ghiaia
Grey gravel

Grigio pietra
Stone grey

Grigio antracite
Anthracite grey

Giallo
Yellow



Arancio
Orange

Rosso Schiffini
Red Schiffini

Rosso Cina
Red Cina

Rosso Bugatti
Red Bugatti

Caffè
Coffee

Celeste
Light blue

Blu Lancia
Blue Lancia



Viola
Purple

Senape
Mustard

Nero
Black

laccati opachi (C2) o lucidi (S2) e Fenix NTM® / mat (C2) or shiny (S2) lacquered finishes and Fenix NTM®



Bianco Malè
Malè white

Bianco Kos
Kos white

Beige Luxor
Luxor beige

Beige Arizona
Arizona beige

Rosa Colorado
Colorado pink

Cacao Orinoco
Orinoco cacao

Rosso Jaipur
Jaipur red



Castoro Ottawa
Ottawa beaver

Grigio Efeso
Efeso grey

Grigio Antrim
Antrim grey

Grigio Bromo
Bromine grey

Grigio Londra
London grey

Verde Comodoro
Comodoro green

Blu Fes
Fes blue



Nero Ingo
Ingo black

laccati effetto metallo / lacquered metal effect



Rame
Copper

Titanio C2
Titanium C2

Silver C2
Silver C2

laminati HPL Unicolor / Unicolor HPL laminate



Bianco 136 U
White 136 U

Avorio 101 U
Ivory 101 U

Sabbia 103 U
Sand 103 U

Grigio 104 U
Grey 104 U

Rosso 105 U
Red 105 U

Antracite 107 U
Anthracite 107 U

Nero 109 U
Black 109 U

legni / woods



Rovere naturale
Natural oak

Noce canaletto
American walnut

Rovere scuro termotrattato
Smoked dark oak

metalli / metals

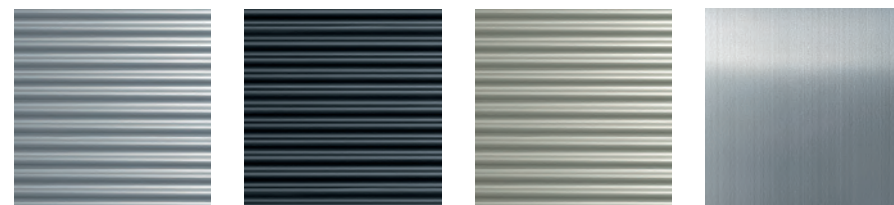

Alluminio
anodizzato naturale
Natural anodized
aluminium

Alluminio
anodizzato nero
Black anodized
aluminium

Alluminio
anodizzato titanio
Titanium anodized
aluminium

Inox satinato
Satin finish ssteel

scafi / carcasses

melamina / melamine



Grigio Antracite
Anthracite grey

Nero con bordo rovere (solo Lepic)
Black with oak edges (Lepic only)

ALSystem / ALSystem

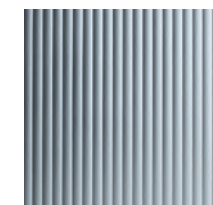

Alluminio naturale
Natural aluminium

piani di lavoro / worktops

legni / woods



Rovere naturale
Natural oak

Noce canaletto
American walnut

Rovere scuro termotrattato
Smoked dark oak

metalli / metals

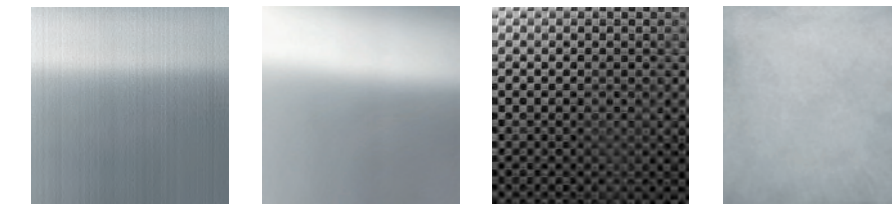

Inox satinato
Satin finish ssteel

Inox lucido
Shiny finish ssteel

Inox antigraffio (top)
Anti scratch ssteel (top)

Inox soft
Soft ssteel

pietre naturali / natural stones

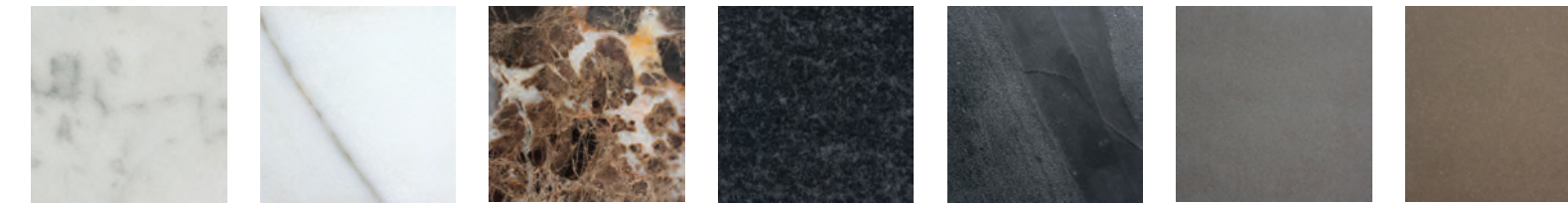

Marmo bianco Carrara
White Carrara marble

Calacatta Caldia
Calacatta Caldia

Emperador Dark
Emperador Dark

Granito nero assoluto
Absolute black granite

Ocean Black
Ocean Black

Quarzite grigia
Grey quartzite

Quarzite beige
Beige quartzite

Corian®

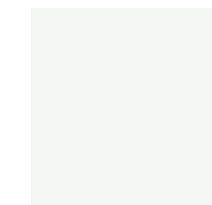

Bianco
White

Silestone®

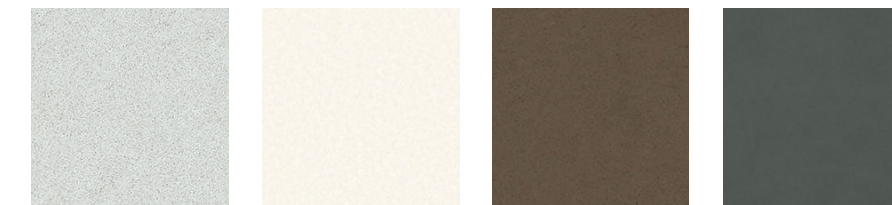

Bianco Norte
Norte white

Bianco Zeus
Zeus white

Unsui
Unsui

Cemento
Cemento

Dekton®

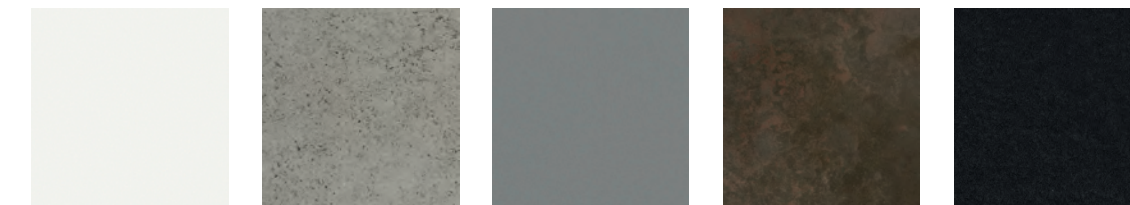

Zenith
Zenith

Keon
Keon

Korus
Korus

Keranium
Keranium

Domoos
Domoos

altri / other

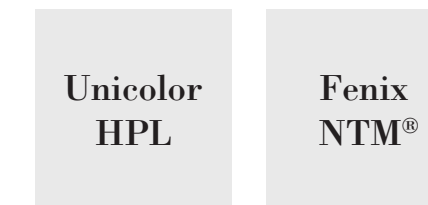

Disponibili nelle stesse finiture delle ante
Available in the same finishes of doors