

**Modulistica basi e pensili (cm)**  
**Base and wall units size range (cm)**

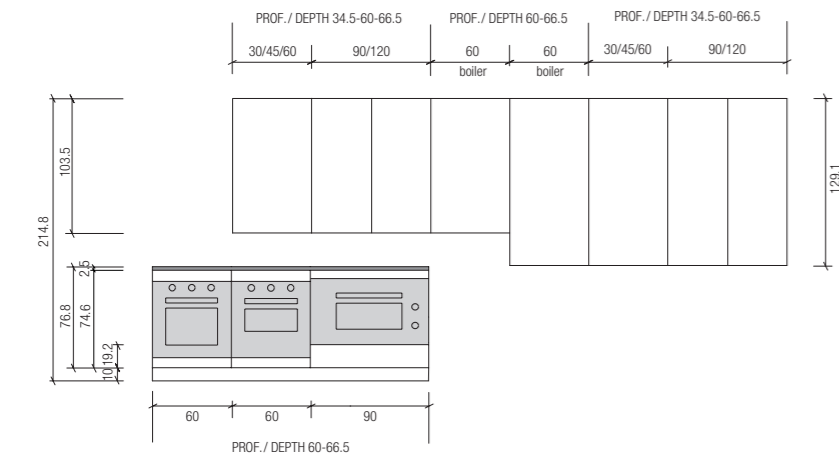

**Modulistica colonne h 142.8 cm**  
**Tall units 142.8 cm high size range**

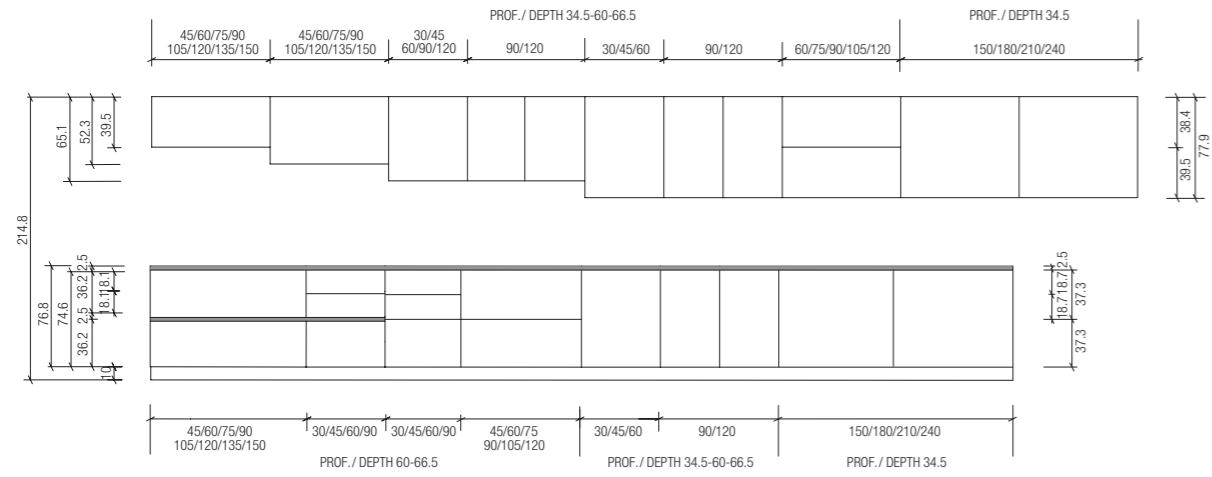
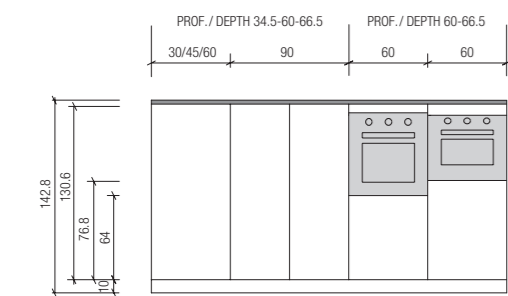

**Modulistica colonne h 214.8 cm**  
**Tall units 214.8 cm high size range**

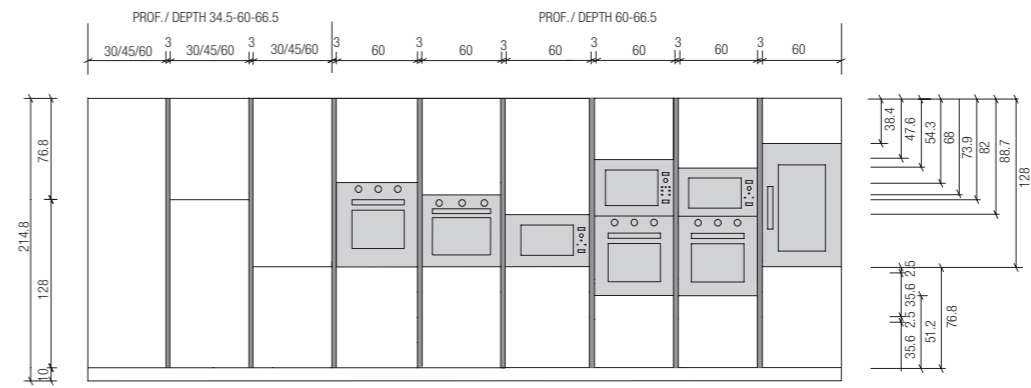

# One Profile

Ante, spessore 22 mm, in MDF idrorepellente per le finiture laccate o in fibra di legno idrorepellente per le altre finiture.

- B** Laminato HPL Unicolor
- C** Laccato opaco
- C** Fenix NTM®
- D** Laccato lucido
- D** Laccato effetto metallo
- D** Legno disponibile nelle finiture
  - Rovere naturale
  - Noce canaletto
  - Rovere scuro termotrattato

**Attenzione**  
Impiallacciatura verticale non continua.

Doors, 22 mm thick, in water-repellent MDF (in lacquered finishes) or in water-repellent wood fibre panels (in the other finishes).

- B** Unicolor HPL laminate
- C** Mat lacquered
- C** Fenix NTM®
- D** Shiny lacquered
- D** Lacquered metal effect
- D** Wood available in the following finishes
  - Natural oak
  - American walnut
  - Smoked dark oak

**Attention**  
Not continuous vertical veneer.

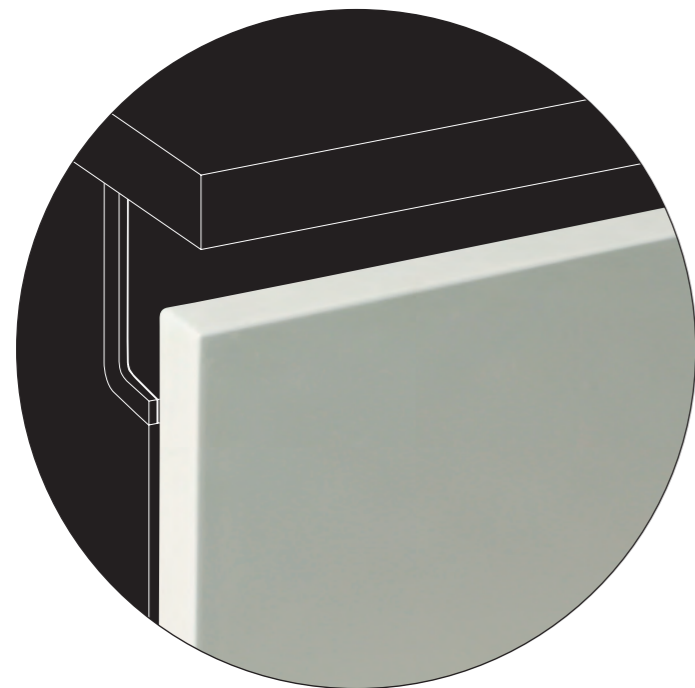

# One Profile

## Particolare struttura / Structure detail

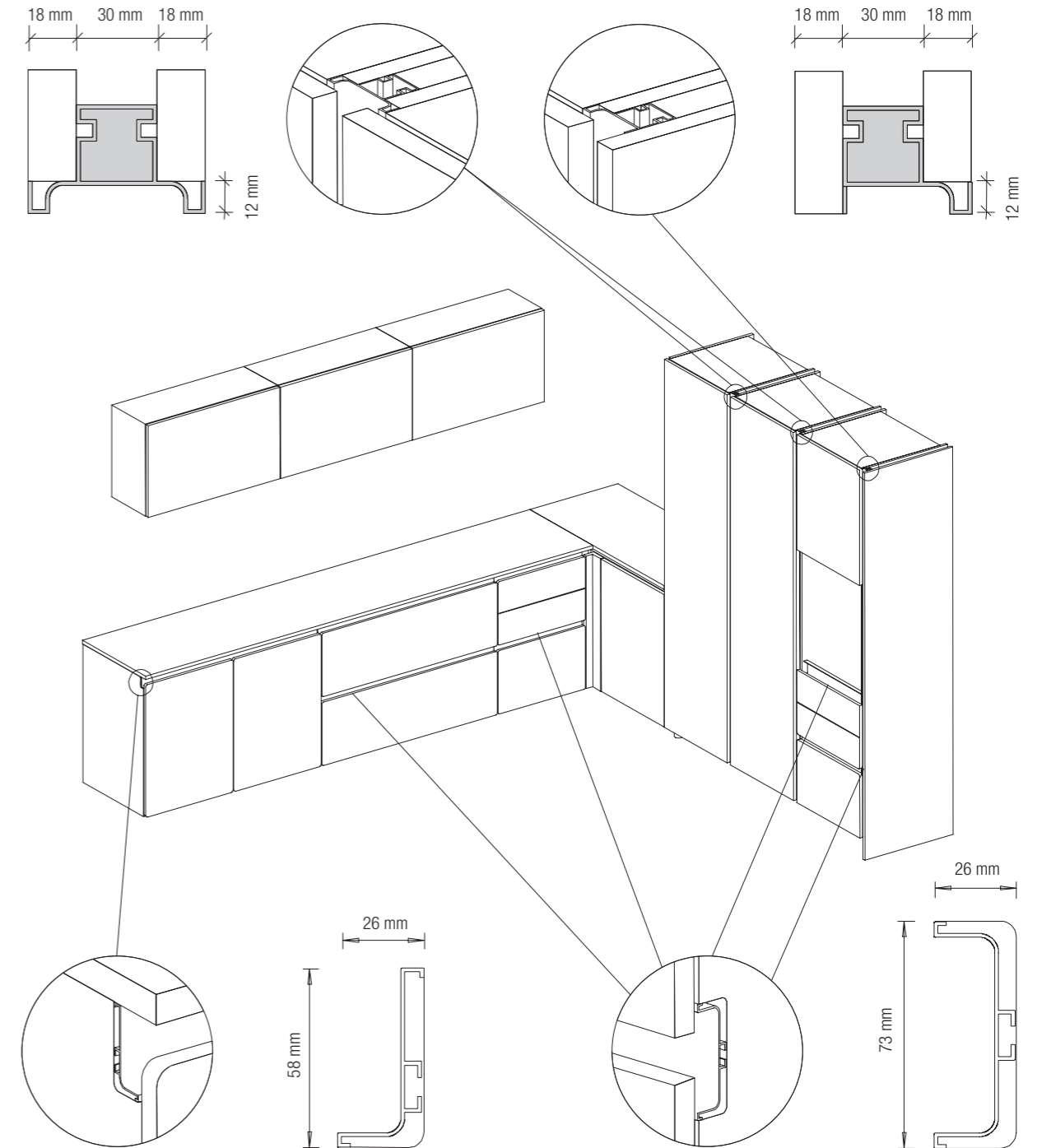

Profili disponibili nelle seguenti finiture:  
 - alluminio anodizzato naturale  
 - laccato opaco nei colori di serie  
 - laccato lucido nei colori di serie

Profiles available in the following finishes:  
 - anodized natural aluminium  
 - mat lacquered in standard colours  
 - shiny lacquered in standard colours

## ante e finiture / doors and finishes

### laccati opachi (C2) o lucidi (S2) / mat (C2) or shiny (S2) lacquered finishes



Bianco  
White

Avorio chiaro  
Light ivory

Beige chiaro  
Light beige

Grigio ghiaia  
Grey gravel

Grigio pietra  
Stone grey

Grigio antracite  
Anthracite grey

Giallo  
Yellow



Arancio  
Orange

Rosso Schiffini  
Red Schiffini

Rosso Cina  
Red Cina

Rosso Bugatti  
Red Bugatti

Caffè  
Coffee

Celeste  
Light blue

Blu Lancia  
Blue Lancia



Viola  
Purple

Senape  
Mustard

Nero  
Black

### laccati opachi (C2) o lucidi (S2) e Fenix NTM® / mat (C2) or shiny (S2) lacquered finishes and Fenix NTM®



Bianco Malè  
Malè white

Bianco Kos  
Kos white

Beige Luxor  
Luxor beige

Beige Arizona  
Arizona beige

Rosa Colorado  
Colorado pink

Cacao Orinoco  
Orinoco cacao

Rosso Jaipur  
Jaipur red



Castoro Ottawa  
Ottawa beaver

Grigio Efeso  
Efeso grey

Grigio Antrim  
Antrim grey

Grigio Bromo  
Bromine grey

Grigio Londra  
London grey

Verde Comodoro  
Comodoro green

Blu Fes  
Fes blue



Nero Ingo  
Ingo black

### laccati effetto metallo / lacquered metal effect



Rame  
Copper

Titanio C2  
Titanium C2

Silver C2  
Silver C2

### laminati HPL Unicolor / Unicolor HPL laminate



Bianco 136 U  
White 136 U

Avorio 101 U  
Ivory 101 U

Sabbia 103 U  
Sand 103 U

Grigio 104 U  
Grey 104 U

Rosso 105 U  
Red 105 U

Antracite 107 U  
Anthracite 107 U

Nero 109 U  
Black 109 U

### legni / woods



Rovere naturale  
Natural oak

Noce canaletto  
American walnut

Rovere scuro termotrattato  
Smoked dark oak

### metalli / metals

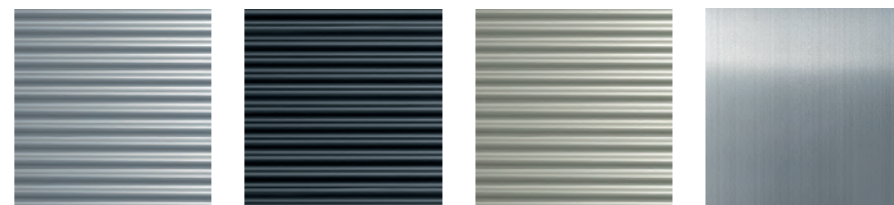

Alluminio anodizzato naturale  
Natural anodized aluminium

Alluminio anodizzato nero  
Black anodized aluminium

Alluminio anodizzato titanio  
Titanium anodized aluminium

Inox satinato  
Satin finish ssteel

### scafi / carcasses

#### melamina / melamine



Grigio Antracite  
Anthracite grey

Nero con bordo rovere (solo Lepic)  
Black with oak edges (Lepic only)

#### ALSystem / ALSystem

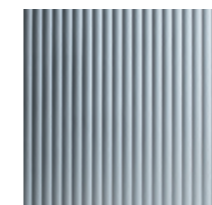

Alluminio naturale  
Natural aluminium

## piani di lavoro / worktops

### legni / woods



Rovere naturale  
Natural oak

Noce canaletto  
American walnut

Rovere scuro termotrattato  
Smoked dark oak

### metalli / metals

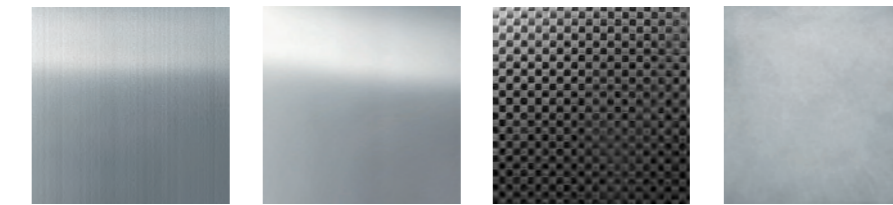

Inox satinato  
Satin finish ssteel

Inox lucido  
Shiny finish ssteel

Inox antigraffio (top)  
Anti scratch ssteel (top)

Inox soft  
Soft ssteel

### pietre naturali / natural stones

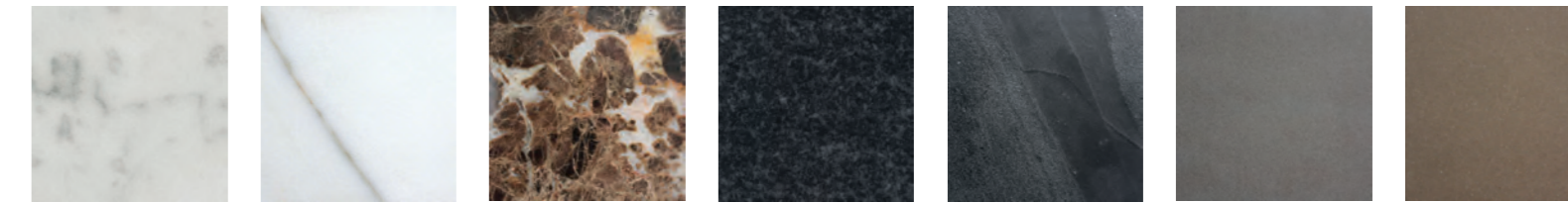

Marmo bianco Carrara  
White Carrara marble

Calacatta Caldia  
Calacatta Caldia

Emperador Dark  
Emperador Dark

Granito nero assoluto  
Absolute black granite

Ocean Black  
Ocean Black

Quarzite grigia  
Grey quartzite

Quarzite beige  
Beige quartzite

### Corian®

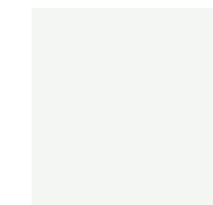

Bianco  
White

### Silestone®

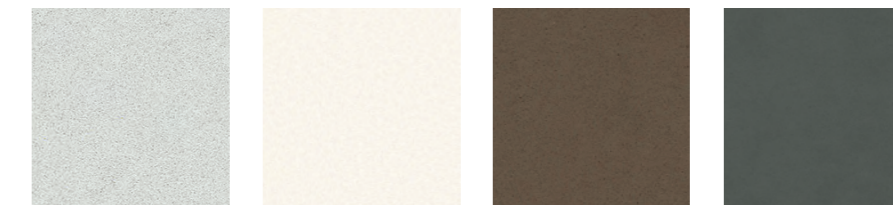

Bianco Norte  
Norte white

Bianco Zeus  
Zeus white

Unsui  
Unsui

Cemento  
Cemento

### Dekton®

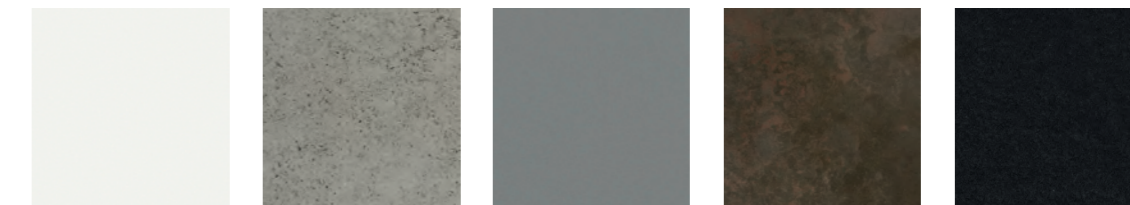

Zenith  
Zenith

Keon  
Keon

Korus  
Korus

Keranium  
Keranium

Domoos  
Domoos

### altri / other

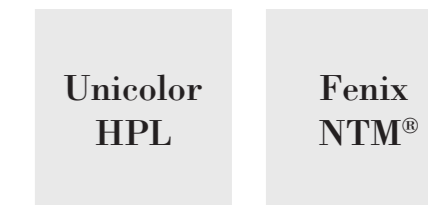

Disponibili nelle stesse finiture delle ante  
Available in the same finishes of doors